

SUPER•EGO

HEAVY DUTY TOOLS

Tarifa de precios

2026

Tabela de preços



www.super-ego.com



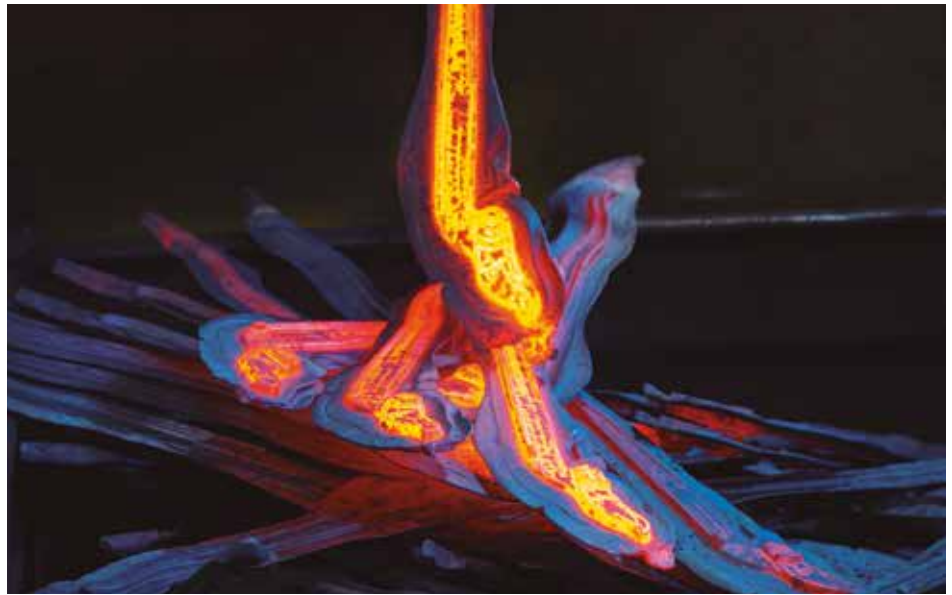

Agarre Apreensão	4	1
Corte Corte	8	2
Roscado y ranurado Abertura de roscas e ranhuragem	12	3
Curvado Ferramentas de curvar	15	4
Soldadura Soldadura	17	5
Comprobación Teste estanquidade	22	6
Equipos y herramientas para HVAC&R Equipamentos e ferramentas para HVAC&R	25	7
Herramienta general Serviços gerais	27	8
Expositores punto de venta / Expositores do ponto de venda Condiciones generales de venta para España / Condições gerais de venda para Portugal	38	9

1



No.	Descripción Descrição	P.V.P. unitario €		EAN 13
122 Llave Heavy Duty / Chave Heavy Duty				
SE1220800*	8"	20,45		8 414162 109084
102100000	10"	50,95		8 414162 1001157
102120000	12"	56,45		8 414162 1001153
102140000	14"	67,95		8 414162 1001188
102180000	18"	90,95		8 414162 1001195
SE1222400*	24"	87,95		8 414162 1090892

* Hasta agotar existencias



104 Llave de Aluminio / Chave de alumínio				
104100000	10"	58,45		8 414162 1000351
104140000	14"	63,45		8 414162 1000382
104180000	18"	86,95		8 414162 1001294
104240000	24"	153,45		8 414162 1001300
104360000	36"	300,95		8 414162 1001317
70164	48"	610,95		4 004625 1701645
1000001640	60"	697,95		4 004625 1408728



121 Llave Stillson ECO / Chave Stillson ECO				
121080000	8"	20,95		8 414162 1001683
121100000	10"	21,45		8 414162 1000352
121120000	12"	23,45		8 414162 1000354
121140000	14"	29,95		8 414162 1000351
121180000	18"	36,95		8 414162 1000358
121240000	24"	66,45		8 414162 1001630
P01010500	Set 12", 14", 18"	88,95		8 414162 1027538



146 Llave sueca ECO "S" / Chave sueca ECO "S"				
100000503	1/2"	11,45		4 004625 1380555
100000504	1"	14,45		4 004625 1380552
100000505	1.1/2"	17,45		4 004625 1380079
100000507	2"	30,45		4 004625 1380086



540 Tenaza pica roscas 540 / Alicata				
540010000	2"	158,65		8 414162 1003335



103 Llave de cadena / Chave de corrente				
103300000	1.1/2"	154,95		8 414162 1001232
103310000	2.1/2"	257,45		8 414162 1001249
103320000	4"	353,95		8 414162 1001256
103330000	6"	553,45		8 414162 1001263
103340000	8"	793,45		8 414162 1001263
103350000	12"	1.291,45		8 414162 1001284

Cadena de repuesto / Corrente de reposição

70263	2.1/2"	48,76		4 004625 1702635
-------	--------	-------	--	------------------



107 Llave de cadena reversible / Chave de corrente reversível				
107120000	4"	53,95		8 414162 1001388
Cadena de repuesto / Corrente de reposição				
70239	4" L: 439 mm	20,35		4 004625 1702390



No.	Descripción Descrição	P.V.P. unitario €		EAN 13
123 Llave de correa / Chave de correia				
123010000	Ø 20 - 200 mm	142,95		1 8 414162 1001720



108 Llave de correa / Chave de correia				
108010000	3"	44,45		4 8 414162 1001429
10801ZZ00	3"	45,76		1 8 414162 1018207
108020000	8"	50,95		4 8 414162 1001423



Correa de repuesto / Correia de reposição				
70268	3" L: 435 mm	15,36		1 4 004625 702680
70269	8" L: 950 mm	27,35		1 4 004625 702697



118 Llave de lavabo / Chave de lavatório				
118010000	32 mm	45,30		1 8 414162 1000338



109 Llave de lavabo / Chave de lavatório				
109010000	32 mm	20,75		1 8 414162 1001438

NOVEDAD



117 Llave de lavabo telescópica / Chave de lavatório telescópica				
117010000	32 mm	27,45		1 8 414162 1001625
117480000	48 mm	31,95		1 8 414162 1001659

Tenaza SEGOGRIP XL / Alicate SEGOGRIP XL				
100005086	16"	94,95		1 4 004625 315000

NOVEDAD



Tenaza SEGOGRIP F / Alicate SEGOGRIP F				
100003706	7"	35,95		1 4 004625 354172
100003707	10"	37,95		1 4 004625 354141

NOVEDAD



Tenaza SEGOGRIP M / Alicate SEGOGRIP M				
100003704	7"	29,95		1 4 004625 354135
100003705	10"	35,95		1 4 004625 354136

1



No.	Descripción Descrição	P.V.P. unitario €		EAN 13
524 Tenaza de canal / Alicate de canal				
520070000	7"	18,45		6
524100000	10"	19,95		6
524120000	12"	29,45		6
500210000	Expo. 12 x 524100000	286,45		1



522 Tenaza de canal / Alicate de canal				
522070000	7"	18,45		6
522100000	10"	20,95		6
522120000	12"	31,95		6
500220000	Expo.12 x 522100000	246,95		1
500110000	Expo. 35 x 522100000	933,95		1



137 Llave de pivote basculante / Chave de gancho ajustável				
137010000	20-50 mm (3/4"-2")	17,88		1
137020000	32-75 mm (1.1/4"-3")	29,95		1
137030000	50-120 mm (2"-4.3/4")	42,50		1
137040000	114-158 mm (4.1/2"-6.1/4")	51,45		1



509 Tenaza de cremallera / Alicate de cremalheira				
509090000*	10"	31,45		6
509120000*	12"	36,95		6
509160000*	16"	78,95		6

* Hasta agotar existencias



Sin bocas de plástico.
Sem bocas de plástico

530 Tenaza de sifón / Alicate de sifão				
530100000	10"	32,95		4
53010ZZ00*	10"	36,02		4
530102000	10" Sin bocas / Sem bocas	32,45		4

* Hasta agotar existencias



Tenazas rusas automáticas con mangos plastificados / Alicates russas automáticas com punhos plastificados				
508090000	9"	19,87		6
508100000	10"	21,38		6



Tenazas rusas con mangos plastificados / Alicates russas con punhos plastificados				
507090000	9"	22,45		6
507100000	10"	24,95		6
500230000	Expo. 35 x 507090000	240,45		1



Tenazas rusas / Alicates russas				
50710C000	10"	21,95		6



No.	Descripción Descrição	P.V.P. unitario €		EAN 13
450 Tornillo de banco / Parafuso de banco				
450020000	2"	187,45	1	8 414 162 1 002109
450030000	3"	268,45	1	8 414 162 1 002116
450040000	4"	375,95	1	8 414 162 1 002123

400 Mordaza de cadena / Braçadeira de corrente

400010000	2.1/2"	141,45	1	8 414 162 1 001938
400020000	4"	204,45	1	8 414 162 1 001942
400030000	6"	313,45	1	8 414 162 1 001959

404 Mordaza de cadena / Braçadeira de corrente

404020000	2.1/2"	187,45	1	8 414 162 1 001966
404040000	4"	281,45	1	8 414 162 1 001973
404060000	6"	375,95	1	8 414 162 1 001980

**464 Banco de trabajo portátil (placa de aluminio)
464 Banco de trabalho portátil (placa de alumínio)**

464000000		561,95	1	8 414 162 1 002933
-----------	--	--------	---	--------------------

Tornillos para mordazas / Parafusos para braçadeiras

464010100		15,25	1	8 414 162 1 016708
-----------	--	-------	---	--------------------

**462 Banco Tristand / 463 con placa curvatubos
462 Banco Tristand / 463 con placa curva-tubos**

462000000	Banco Tristand	208,95	1	8 414 162 1 005357
463000000	Banco con placa curvatubos	233,95	1	8 414 162 1 005354

Tornillos para mordazas / Parafusos para braçadeiras

462010200		12,20	1	8 414 162 1 098959
-----------	--	-------	---	--------------------

Banco de trabajo 2 en 1 / Bancada de trabalho 2 em 1

1500000530	6"	753,95	1	4 1004623 380833
------------	----	--------	---	------------------













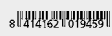

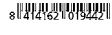
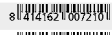
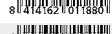
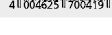





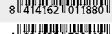
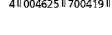



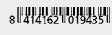

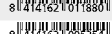
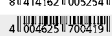





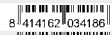

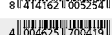
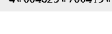



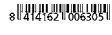
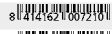

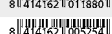
No. 735000000

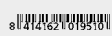

No. 735050000

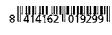
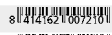

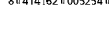
No.	Descripción Descrição	P.V.P. unitario €		EAN 13
716 Cortatubos MINI PRO / 722 Cortatubos MINI PRO Corta-tubos MINI PRO / Corta-tubos MINI PRO				
716200000	3-16 mm (1/8"-5/8") 1 cuchilla/lámina Cu-Al	17,95		4 
722200000	6-22 mm (1/4"-7/8") 1 cuchilla/lámina Cu-Al	19,45		4 
Accesorios/ acessórios				
735000500	Cuchillas / Láminas Cu-Al	7,95		5 
735001500	Cuchillas / Láminas Inox	9,60		5 
70041	Eje / Eixo	1,45		1 
7221 Cortatubos MINICUT / 728 Cortatubos MINI-MAX PRO Corta-tubos MINICUT / Corta-tubos MINI-MAX PRO				
722100000	6-22 mm (1/4"-7/8") 1 cuchilla/lámina Cu-Al	18,95		4 
728000000	3-28 mm (1/8"-1.1/8") 1 cuchilla/lámina Cu-Al	24,45		4 
Accesorios/ acessórios				
735000500	Cuchillas / Láminas Cu-Al	7,95		5 
735010500	Cuchillas / Láminas MLP	7,80		5 
735001500	Cuchillas / Láminas Inox	9,60		5 
70041	Eje / Eixo	1,45		1 
725 Cortatubos estándar PRO/ Corta-tubos padrão PRO				
725220000	3-30 mm (1/8"-1.1/8")	20,95		4 
725200000	3-30 mm (1/8"-1.1/8") 2 cuchillas/láminas Cu-Al	21,95		4 
Accesorios/ acessórios				
735000500	Cuchillas / Láminas Cu-Al	7,95		5 
735010500	Cuchillas / Láminas MLP	7,80		5 
735001500	Cuchillas / Láminas Inox	9,60		5 
763012200	Cuchillas / Láminas PP-PE	10,95		5 
70041	Eje / Eixo	1,45		1 
726 Cortatubos PRO / Corta-tubos PRO				
726020000	12-50 mm (1/2"-2") 2 cuchillas: Cu-Al y PP, PE	36,56		4 
726000000	12-50 mm (1/2"-2") 2 cuchillas/láminas Cu-Al	36,56		4 
Accesorios/ acessórios				
735000500	Cuchillas / Láminas Cu-Al	7,95		5 
735010500	Cuchillas / Láminas MLP	7,80		5 
735001500	Cuchillas / Láminas Inox	9,60		5 
763012200	Cuchillas / Láminas PP-PE	10,95		5 
70041	Eje / Eixo	1,45		1 
735 Cortatubos telescópico PRO / Corta-tubos telescópico PRO				
735000000	6-35 mm (1/4"-1.3/8") 2 cuchillas/láminas Cu-Al	46,95		
735050000	6-35 mm (1/4"-1.3/8") 2 cuchillas/láminas Inox	54,95		
Accesorios/ acessórios				
735000500	Cuchillas / Láminas Cu-Al	7,95		5 
735010500	Cuchillas / Láminas MLP	7,80		5 
735001500	Cuchillas / Láminas Inox	9,60		5 
763012200	Cuchillas / Láminas PP-PE	10,95		5 
21652	Escariador/escareadora Cu-Al	5,90		1 
735002300	Escariador/escareadora Inox	5,35		1 
742 Cortatubos telescópico / Corta-tubos telescópico				
742000000	6-42 mm (1/4"-1.5/8") 2 cuchillas/láminas Cu-Al	65,45		4 
74200ZB00	6-42 mm (1/4"-1.5/8") 2 cuchillas/láminas: Inox y MLP	72,95		4 
Accesorios/ acessórios				
735000500	Cuchillas / Láminas Cu-Al	7,95		5 
735010500	Cuchillas / Láminas MLP	7,80		5 
735001500	Cuchillas / Láminas Inox	9,60		5 
763012200	Cuchillas / Láminas PP-PE	10,95		5 



No.	Descripción Descrição	P.V.P. unitario €		EAN 13
750 Cortatubos automático / Corta-tubos automático				
750000000	6-67 mm (1/4"-2.5/8") 2 Cuchillas Cu-Al	139,45		5 8 414162 1006978
750010000	6-67 mm (1/4"-2.5/8") 2 Cuchillas PP, PE	144,95		5 8 414162 1006978

Accesorios/ acessórios

735000500	Cuchillas / Lâminas Cu-Al	7,95		5 8 414162 1007210
735010500	Cuchillas / Lâminas MLP	7,80		5 8 414162 1034186
763012200	Cuchillas / Lâminas PP-PE	10,95		5 8 414162 1005924
70042	Eje / Eixo	5,40		1 4 1004623 1706226
751004100	Escariador / Escareador	13,45		1 4 1004623 1706226

**751/752 Cortatubos automático / Corta-tubos automático**

751000000	50-127 mm (2"-5") Cuchilla PP, PE 8 mm	239,95		1 8 414162 1019824
751010000	50-127 mm (2"-5") Cuchilla PP, PE 13 mm	249,45		1 8 414162 1006787
751020000	50-127 mm (2"-5") Cuchilla PP, PE	193,95		1 8 414162 1006866
752030000	100-168 mm (4"-6.5/8") Cuchilla PP, PE	234,55		1 8 414162 1006800

Accesorios/ acessórios

737000500	Cuchilla Cu-Al	13,95		8 8 414162 1005261
737012200	Cuchilla PP, PE Ø 40 mm	22,95		8 8 414162 1005278
737032200	Cuchilla PP, PE Ø 30,5 mm	23,95		8 8 414162 1011921
738012200	Cuchilla PP, PE Ø 45 mm	23,95		8 8 414162 1011938
70042	Eje / Eixo	5,40		1 4 1004623 1706226
751004100	Escariador / Escareador	13,45		1 8 414162 012023

**701 Cortatubos para hierro / Corta-tubos para ferro**

701010000	10-42 mm (1/8" -1.1/4")	135,95		1 8 414162 1004163
701020000	10-60 mm (1/8"-2")	161,45		1 8 414162 1004110

Accesorios/ acessórios

701010500	Cuchilla Fe 1.1/4"	15,45		5 8 414162 1005230
710020500	Cuchilla Fe 2"	20,45		5 8 414162 1005223
701011500	Eje / Eixo 1.1/4"	6,60		1 8 414162 1098607

**710 Cortatubos para hierro / Corta-tubos para ferro**

710040000	60-115 mm (2"-4")	304,95		1 8 414162 1004121
-----------	-------------------	--------	--	----------------------

Accesorios/ acessórios

710040500	Cuchilla / Lâmina Fe 4"	29,95		3 8 414162 1005333
70064	Eje / Eixo 4"	7,35		1 4 1004623 1706248

**Tijera para tubos de plástico ECO / Ø 32 mm
Tesoura para tubos de plástico ECO Ø 32 mm**

568B10000	0-32 mm (0-1.1/4")	21,95		5 8 414162 1005240
-----------	--------------------	-------	--	----------------------

**Tijera para tubos de plástico ECO Ø 42 mm
Tesoura para tubos de plástico ECO Ø 42 mm**

568B20000	0-42 mm (0-1.5/8")	27,45		5 8 414162 1005248
-----------	--------------------	-------	--	----------------------

2



No.	Descripción Descrição	P.V.P. unitario €		EAN 13
Tijera para tubos de plástico Ø 26 mm / Tesoura para tubos de plástico Ø 26 mm				
568060000	0-26 mm (0-1")	41,45		4 8 414162 1013123



Tijera para tubos de plástico Ø 32 mm / Tesoura para tubos de plástico Ø 32 mm				
568400000	0-32 mm (0-1.1/4")	58,95		4 8 414162 1031879
Accesorios/ acessórios				
568400300	Cuchilla / Lâmina	30,95		1 8 414162 1051086



Tijera para tubos de plástico Ø 42 mm / Tesoura para tubos de plástico Ø 42 mm				
568020000	0-42 mm (0-1.5/8")	75,95		4 8 414162 1013921
500520000	Expositor 10 x 568020000	688,95		1 8 414162 1021149
Accesorios/ acessórios				
568022400	Cuchilla / Lâmina	44,95		1 8 414162 1014252



Tijera para tubos de plástico Ø 50 mm / Tesoura para tubos de plástico Ø 50 mm				
568050000	0-50 mm (0-2")	107,95		4 8 414162 1019916
Accesorios/ acessórios				
568052400	Cuchilla / Lâmina	46,95		1 8 414162 1024993



Tijera para tubos de plástico Ø 63 mm / Tesoura para tubos de plástico Ø 63 mm				
568630000	0-63 mm (0-2.1/2")	157,45		1 8 414162 1078326
Accesorios/ acessórios				
568632400	Cuchilla / Lâmina	49,95		1 8 414162 1078333



Tijera para tubos de plástico Ø 75 mm / Tesoura para tubos de plástico Ø 75 mm				
568750000	0-75 mm (0-3")	262,45		1 8 414162 1023524
Accesorios/ acessórios				
568752400	Cuchilla / Lâmina	73,95		1 8 414162 1024933

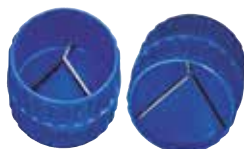

Escariador interno-externo / Escariador interno-externo				
1500002738	4-40 mm (1/8"-1.5/8")	14,95		1 4 004625 464823



No.	Descripción Descrição	P.V.P. unitario €		EAN 13
Sierra de cinta portátil SEGOBAND P152				
1500004730	Ø 152 mm	1.467,95	1	
Accesorios/ acessórios				
1500004917	5 hojas. 1735 x 13 x 0,9 mm. Z1"	111,95	1	
1500004947	5 hojas. 1735 x 13 x 0,9 mm. Z1"	111,95	1	
1500004920	Base	274,45	1	



Sierra de cinta de bancada automática SEGOBAND B225				
1500004731	Ø 225 mm	4.411,45	1	
Accesorios/ acessórios				
1500004913	5 hojas. 2565 x 27 x 0,9 mm. Z1"	142,95	1	
1500004941	5 hojas. 2565 x 27 x 0,9 mm. Z1"	142,95	1	
1500004942	5 hojas. 2565 x 27 x 0,9 mm. Z1"	142,95	1	



Sierra de cinta de bancada automática SEGOBAND B255				
1500004732	Ø 255 mm	6.900,45	1	
Accesorios/ acessórios				
1500004911	5 hojas. 2750 x 27 x 0,9 mm. Z1"	152,95	1	

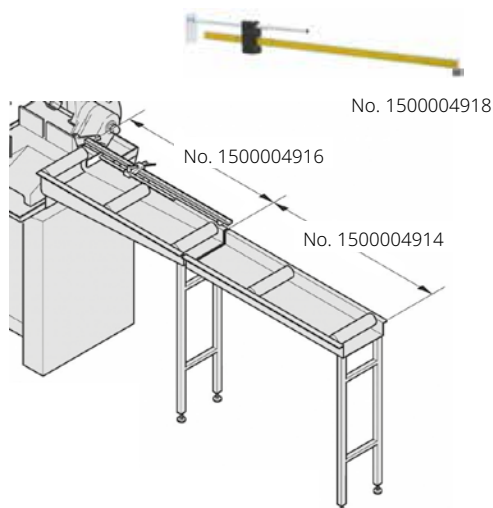

Accesorios para SEGOBAND B225 y B255				
1500004914	Soporte de carga/descarga	433,45	1	
1500004916	Rodillo módulo adicional	382,45	1	
1500004918	Varilla de sujeción milimetrada	172,45	1	



3

No.	Descripción Descrição	P.V.P. unitario €		EAN 13
Cabezas de terrajas / Cabeças de terraxas				
6002D0000	BSPT-D 1/4"	100,95	1	8 414 162 1 00355
6003D0000	BSPT-D 3/8"	100,95	1	8 414 162 1 00368
6004D0000	BSPT-D 1/2"	112,95	1	8 414 162 1 003618
6005D0000	BSPT-D 3/4"	112,95	1	8 414 162 1 003629
6006D0000	BSPT-D 1"	120,95	1	8 414 162 1 003676
6007D0000	BSPT-D 1.1/4"	120,95	1	8 414 162 1 003700
6008D0000	BSPT-D 1.1/2"	120,95	1	8 414 162 1 003731
6009D0000	BSPT-D 2"	194,45	1	8 414 162 1 003783
6002N0000	NPT 1/4"	106,95	1	8 414 162 1 003911
6003N0000	NPT 3/8"	100,95	1	8 414 162 1 003601
6004N0000	NPT 1/2"	112,95	1	8 414 162 1 003632
6005N0000	NPT 3/4"	112,95	1	8 414 162 1 003653
6006N0000	NPT 1"	118,45	1	8 414 162 1 003694
6007N0000	NPT 1.1/4"	118,45	1	8 414 162 1 003724
6008N0000	NPT 1.1/2"	118,45	1	8 414 162 1 003755
6009N0000	NPT 2"	188,45	1	8 414 162 1 006671
6000M1600	Métrica 16 x 1,5	122,45	1	8 414 162 1 019313
6000M2000	Métrica 20 x 1,5	129,95	1	8 414 162 1 019344
6000M2500	Métrica 25 x 1,5	142,95	1	8 414 162 1 019800
6000M3200	Métrica 32 x 1,5	142,95	1	8 414 162 1 019812



No.	Descripción Descrição	P.V.P. unitario €		EAN 13
Juego de peines / Jogo de pentes				
6002D4000	BSPT-D 1/4"	56,45	1	8 414 162 1 011569
6003D4000	BSPT-D 3/8"	69,45	1	8 414 162 1 010104
6004D4000	BSPT-D 1/2"	72,45	1	8 414 162 1 000918
6005D4000	BSPT-D 3/4"	74,45	1	8 414 162 1 000921
6006D4000	BSPT-D 1"	78,45	1	8 414 162 1 000932
6007D4000	BSPT-D 1.1/4"	80,95	1	8 414 162 1 010111
6008D4000	BSPT-D 1.1/2"	83,45	1	8 414 162 1 011606
6009D4000	BSPT-D 2"	88,45	1	8 414 162 1 007296
6002N4000	NPT 1/4"	57,95	1	8 414 162 1 011576
6003N4000	NPT 3/8"	69,45	1	8 414 162 1 013679
6004N4000	NPT 1/2"	72,45	1	8 414 162 1 006688
6005N4000	NPT 3/4"	74,45	1	8 414 162 1 006693
6006N4000	NPT 1"	78,45	1	8 414 162 1 006701
6007N4000	NPT 1.1/4"	80,95	1	8 414 162 1 006718
6008N4000	NPT 1.1/2"	83,45	1	8 414 162 1 006725
6009N4000	NPT 2"	88,45	1	8 414 162 1 006732



No.	Descripción Descrição	P.V.P. unitario €		EAN 13
Maneral / Manilha				
600000000	1/4-1.1/4"	167,45	1	8 414 162 1 004912
600010000	1.1/2-2"	167,95	1	8 414 162 1 007227



No.	Descripción Descrição	P.V.P. unitario €		EAN 13
Escariador / Escareador				
785200000		291,45	1	4 1004623 1 702895



No.	Descripción Descrição	P.V.P. unitario €		EAN 13
Adaptador / Adaptador				
600011500	1/4"-3/8"-1/2"-3/4"-1.1/4"	35,95	1	8 414 162 1 012771
862009000	Auto. 1/4"-3/8"-1/2"-3/4"-1.1/4"	151,95	1	4 1004623 1 377109



No.	Descripción Descrição	P.V.P. unitario €		EAN 13
-----	--------------------------	----------------------	---	--------

600 Set PROMO

600240600	BSPT 1/2"-1.1/4"	253,45		8 414162 1006743
600240900	BSPT 1/2"-1"	226,45		8 414162 1006763

600 Set COMPACTO

600220500	BSPT 3/8" - 1/2"- 3/4"- 1" - 1.1/4"	562,45	1	8 414162 1005119
600220600	BSPT 1/2"- 3/4"- 1" - 1.1/4"	492,95	1	8 414162 1005148
600220800	BSPT 3/8" - 1/2"- 3/4"- 1"	478,95	1	8 414162 1005179
600220900	BSPT 1/2"- 3/4"- 1"	383,95	1	8 414162 1005193
600223600	BSPT 1/2"- 3/4"- 1" - 1.1/4"	493,95	1	8 414162 1005131
600223900	BSPT 1/2"- 3/4"- 1"	410,95	1	8 414162 1005209

600 Set profesional

600230100	BSPT-D 3/8"-2"	949,45	1	8 414162 1005193
600230200	BSPT-D 1/2"-2"	600,95	1	8 414162 1007261
600230500	BSPT-D 1.1/4"-2"	585,95	1	8 414162 1008361
600230600	BSPT-D 1.1/2"-2"	561,95	1	8 414162 1008378
600233200	NPT 1/2"-2"	721,95	1	8 414162 1008382
600233400	NPT 1"-2"	534,45	1	8 414162 1011590
6002M0000	Métrica 16-20-25-32	532,95	1	8 414162 1019952

Equipo básico del fontanero / Equipamento básico para o canalizador

S00630000	BSPT 1/2"- 3/4"- 1"	434,45	1	8 414162 1006117
-----------	---------------------	--------	---	------------------

662 Terrajas ajustables 4" / Terraxas ajustáveis 4"

662200100	BSPT-D 1.1/2"-4"	1.971,95	1	8 414162 1008460
662200300	BSPT-D 2.1/2"-4"	1.861,95	1	8 414162 1008488
662200500	BSPT-D 1.1/2"-3"	1.861,95	1	8 414162 1008484

**Roscadora electroportátil SUPERTRONIC 1250
Rosqueadeira electroportátil SUPERTRONIC 1250**

866200000	BSPT 1/2"-1.1/4" 220V	842,95	1	8 414162 1009430
865008700	Fijatubos	115,95	1	8 414162 1038238

**Roscadora electroportátil SUPERTRONIC 2000
Rosqueadeira electroportátil SUPERTRONIC 2000**

864120200	BSPT 1/2"-2"	1.713,45	1	8 414162 020325
-----------	--------------	----------	---	-----------------

Accesorios / acessórios

71280	Fijatubos / Fixa-tubos	188,56	1	4 004825 712801
600011500	Adaptador monoblock	35,95	1	4 004825 377109
8387080	Portaesobilla+escobilla	13,45	1	4 004825 870808
887092000	Accesorio para ranurar 2"-6"	1.602,45	1	8 414162 1021124



Mod. 215



Mod. 415



No.	Descripción Descrição	P.V.P. unitario €		EAN 13
-----	--------------------------	----------------------	--	--------

Máquina roscadora de bancada 2" Mod. 215

886420000	BSPT	2.952,88	1	
1500002913	NPT	2.952,88	1	

Máquina roscadora de bancada 4" Mod. 415

1500001486	BSPT	4.890,67	1	
1500001591	NPT	4.794,03	1	

Juego 4 peines métricos / Jogo 4 pentes métricos

1500005186	10 mm. Paso / passo 1,5	168,45		1	
1500005187	12 mm. Paso / passo 1,75	168,45		1	
1500005188	14-16 mm. Paso / passo 2	168,45		1	
1500005189	20-22 mm. Paso / passo 2,5	168,45		1	
1500005190	24-27 mm. Paso / passo 3	168,45		1	
1500005191	30-33 mm. Paso / passo 3,5	168,45		1	

Juego 4 peines para roscadoras / Jogo 4 pentes para roscadeiras Mod. 215-2" y Mod. 415-4"

Juego 4 peines 1/2 - 3/4". Sección / Seção 27 x 9,5 mm

886427000	BSPT	179,95		1	
886428000	NPT	179,95		1	

Juego 4 peines 1 - 2". Sección / Seção 27 x 9,5 mm

886427100	BSPT	179,95		1	
886428100	NPT	179,95		1	

Juego 4 peines 2.1/2 - 4". Sección / Seção 22,20 x 15,80 mm

1000001450	BSPT	179,95		1	
1000001451	NPT	179,95		1	

**Aceite de roscar mineral / Aceite de roscar sintético
Óleo de enroscar mineral Óleo de enroscar sintético**

899100100	Mineral spray 600 ml.	15,95		12	
SEH020600	Mineral 5 l.	46,95		1	
899102500	Mineral bidón 25 l.	193,90		1	
899200100	Sintético spray 600 ml.	16,38		12	
SEH020200	Sintético 5 l.	50,95		1	

Soporte para tubos 12" / Suporte para tubos 12"

1500003161	Regulable en altura	172,45		1	
------------	---------------------	--------	--	---	--

Accesorio para ranurar / Acessório para ranhurar

887092000	Para SUPERTRONIC 2000	1.602,45		1	
-----------	-----------------------	----------	--	---	--

Rodillo y eje de ranurado / Rodízios e eixo

887090500	1"	624,45			
887090600	1.1/4" - 1.1/2"	624,45		1	
887090700	2"-6"	624,45		1	

Base de montaje de repuesto

56515	Para SUPERTRONIC 2000	79,95		1	
1000004890	Para roscadora Mod. 415	165,45		1	

Máquina ranuradora 2" - 12" / Ranhuradora 2" - 12"

1500001987		3.314,00		1	
------------	--	----------	--	---	--

Conjunto rodillo superior e inferior / Conjunto de rolos superior e inferior

887307000	2" - 6"	421,95		1	
887308000	3" - 6"	440,45		1	

Soporte para tubo 2" - 12" / Suporte para tubos 2" - 12"

1500000133	2" - 6"	636,95		1	
------------	---------	--------	--	---	--



No.	Descripción Descrição	P.V.P. unitario €		EAN 13
769 Muelle curvatubos / Mola curva-tubos				
76910ZZ00	10 mm	10,15		8 414162 100039
76912ZZ00	12 mm	11,65		8 414162 1000105
76915ZZ00	15 mm	12,75		8 414162 1000112
769000000	3/8" - 1/2" - 5/8"	30,95		
761 Tenaza curvatubos / Tenaza curva-tubos				
761000000	6-8-10 mm	33,95		8 414162 1005780
761020000	1/4"-5/16"-3/8"	33,95		8 414162 1005858
760 Tenaza curvatubos / Tenaza curva-tubos				
760060000	6 mm	50,95		8 414162 1000372
760080000	8 mm	62,45		8 414162 1000389
760100000	10 mm	63,45		8 414162 1000396
760120000	12 mm	66,45		8 414162 1000273
760140000	14 mm	80,45		8 414162 1000396
760150000	15 mm	82,45		8 414162 1000280
760160000	16 mm	84,45		8 414162 1000360
760180000	18 mm	104,95		8 414162 1000377
Uñas				
760060300	6 mm	12,45		8 414162 1000366
760080300	8 mm	13,95		8 414162 1000444
760100300	10 mm	15,95		8 414162 1000303
760120300	12 mm	15,95		8 414162 1000242
760150300	15 mm	16,35		8 414162 1000310
760180300	18 mm	20,37		8 414162 1000377
765 Tenaza curvatubos / Tenaza curva-tubos				
765100000	10 mm	116,45		8 414162 1000456
765120000	12 mm	133,45		8 414162 1000458
765140000	14 mm	152,95		8 414162 1000395
765160000	16 mm	179,45		8 414162 1000468
765180000	18 mm	189,45		8 414162 1000415
Curvadoras hidráulicas / Curvadoras hidráulicas				
2" Placa simple / placa simple				
1000001833	3/8"-2" radio corto	1.891,45		4 004625 413944
1000001835	3/8"-2" radio largo	1.993,95		4 004625 406640
2" Placa doble / placa dupla				
1000001832	3/8"-2" radio corto	2.035,95		4 004625 406626
1000001834	3/8"-2" radio largo	2.175,45		4 004625 406633
3" Placa doble / placa dupla				
1500002308	1/2"-3" radio largo	2.674,45		4 004625 406657
Hormas radio corto / Formas raio curto				
57985	3/8"	24,45		4 004625 579855
57986	1/2"	30,95		4 004625 579862
57987	3/4"	44,45		4 004625 579879
57988	1"	74,95		4 004625 579886
57989	1.1/4"	100,95		4 004625 579893
57990	1.1/2"	117,45		4 004625 579900
57991	2"	151,95		4 004625 579917
Hormas radio largo / Formas raio longo				
58010	3/8"	22,95		4 004625 580103
58011	1/2"	31,95		4 004625 580110
58012	3/4"	47,95		4 004625 580127
58013	1"	78,45		4 004625 580134
58014	1.1/4"	106,45		4 004625 580141
58015	1.1/2"	127,45		4 004625 580158
58016	2"	146,45		4 004625 580165
7M3005200	2.1/2"	359,95		8 414162 100836
7M3005300	3"	586,95		8 414162 100843
Diábolos / Diabolôs				
772201200	Derecho / Direito	139,45		8 414162 1098645
772201100	Izquierdo / Esquerdo	138,45		8 414162 1098638
Tripode / Tripé				
57352		249,45		4 004625 573525

4

4



No.	Descripción Descrição	P.V.P. unitario €		EAN 13
-----	--------------------------	----------------------	---	--------

Curvadora hidráulica manual ECO / Curvadora hidráulica manual ECO

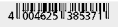



100000757	3/8" - 2"	974,95	1	
-----------	-----------	--------	---	---

Curvadora electroportátil ROBEND 4000



Dobrador de tubos mecánico portátil ROBEND 4000

1200001367	Máquina ROBEND 4000	1.638,45	1	
------------	---------------------	----------	---	---

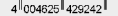
Conjuntos: máquina + hormas y patines

1000001535	15, 18 y 22 mm	2.138,45	1	
1000001534	15, 18, 22 y 28 mm	2.281,45	1	
1000001532	12, 15, 18, 22 y 28 mm	2.278,95	1	
1000001538	1/2", 5/8", 3/4", 7/8", 1"	1.972,95	1	
1000001537	20, 25 y 32 mm Conduit/MLP	1.972,95	1	
1000001536	16, 20, 25 y 32 mm Conduit/MLP	2.122,95	1	

Accesorios/ acessórios

995808400	Estuche / Estojo	115,15	1	
25748	Trípode / Tripé	134,95	1	
25743	Bulón / Perno	34,45	1	







Set hormas / Set de formas O.D. mm (Cu-Al, SS Inox)

25612	12 mm	128,88	1	
25614	14 mm	143,45	1	
25615	15 mm	137,95	1	
25616	16 mm	146,45	1	
25618	18 mm	181,45	1	
25622	22 mm	190,95	1	
25628	28 mm	286,45	1	

Set hormas / Set de formas Conduit

25616	16 mm	146,45	1	
25620	20 mm	180,95	1	
762935500	25 mm	204,45	1	
25666	32 mm	350,95	1	



Set hormas / Set de formas O.D. pulgadas (Cu-Al, Inox)

25652	1/2"	137,95	1	
762955300	5/8"	151,45	1	
25619	3/4"	181,45	1	
762955700	7/8"	212,95	1	
25625	1"	218,95	1	
25626	1.1/8"	268,45	1	

Set hormas / Set de formas Nominal D pulgadas " (acero)

762965100	(2440-41) 1/4"	128,95	1	
762965200	(2440-41) 3/8"	132,95	1	
25684	(2440-41) 1/2"	164,95	1	
25685	(2440-41) 3/4"	287,45	1	







Set hormas / Set de formas 4R (Cu, Multicapa)

1000001561	1.1/4"-32 mm	357,45	1	
1000001563	1.3/8"-35 mm	427,95	1	



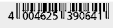

No.	Descripción Descrição	P.V.P. unitario €		EAN 13
-----	--------------------------	----------------------	---	--------

Candileja SEGOFLAME / Candileja SEGOFLAME PIEZO Candileja SEGOFLAME / Candileja SEGOFLAME PIEZO

3593000	SEGOFLAME	46,45		1	
P00591000	SEGOFLAME + 3 cartuchos	53,95		1	
3593100	SEGOFLAME PIEZO	70,45		1	
Cartucho desechable / Cartucho descartável					
1500001065	BTP C-200 PRO	5,30		36	

Candileja ECO PIEZO / Candileja

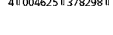
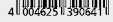
SEH025100	ECO PIEZO	25,95		1	
1000000364	ECO PIEZO + 3 cartuchos	38,95		1	
Cartucho desechable / Cartucho descartável					
1500001065	BTP C-200 PRO	5,30		36	

Soplete tipo pistola / Maçarico tipo pistola

1500001304	Soplete tipo pistola	25,45		1	
Cartucho desechable / Cartucho descartável					
1500000587	C470	9,95		12	
SEH020300	BTP 300 SUPER-EGO	8,50		24	

Sopletes SEGOFIRE / Sopletes SEGOFIRE PIEZO Maçaricos SEGOFIRE / Maçaricos SEGOFIRE PIEZO

3550100	SEGOFIRE + BTP 300	48,95		1	
3555500	SEGOFIRE PIEZO + BTP 300	53,95		1	
P00555500	SEGOFIRE PIEZO + 3 BTP 300	71,45		1	
Cartucho desechable / Cartucho descartável					
SEH020300	BTP 300 SUPER-EGO	8,50		24	
Repuestos / Reposições					
223432200	Quegador SEGOFIRE	18,25		1	
35561	Quegador SEGOFIRE PIEZO	20,45		1	
254202300	Anillo de goma (exterior)	6,65		1	
254201100	Junta tórica (interior)	3,30		1	

Soplete EASY-FIRE / Maçarico EASY-FIRE

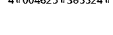
R3555300	EASYFIRE	32,95		1	
1000000768	EASY-FIRE + 2 BTP 300	43,95		1	
Cartucho desechable / Cartucho descartável					
SEH020300	BTP 300 SUPER-EGO	8,50		24	

Soplete MULTIFIRE / Maçarico MULTIFIRE

SEH024700	MULTIFIRE	28,45		1	
1000000419	MULTI FIRE + 2 BTN 250	33,95		1	
Cartucho desechable / Cartucho descartável					
SEH003800	BTN 250	4,75		28	



No.	Descripción Descrição	P.V.P. unitario €		EAN 13
-----	--------------------------	----------------------	--	--------

Soplete PRO-FIRE / Maçarico PRO-FIRE

1500002771	Soplete PRO-FIRE	123,45		1	
1500002772	PRO-FIRE + 2 ROMASSGAS	144,95		1	



Soplete SUPER-FOGO / Maçarico SUPER-FOGO

254400000	SUPER FOGO	43,45		1	
1000000767	SUPER-FOGO + 2 ROMASSGAS	71,95		1	

Cartucho desechable / Cartucho descartável

SEH024600	ROMASSGAS	22,95		12	
-----------	-----------	-------	--	----	--

Adaptadores / Adaptadores

263003400	USA - EU	13,70		1	
263003900	EU - USA	11,95		1	



Soplete POWER-FIRE Compact / Maçarico POWER-FIRE Compact

254800000	POWER-FIRE Compact USA	97,95		1	
254800100	POWER-FIRE Compact + ROMASSGAS	123,45		1	

Cartucho desechable / Cartucho descartável

SEH024600	ROMASSGAS	22,95		12	
-----------	-----------	-------	--	----	--

Adaptadores / Adaptadores

263003400	USA - EU	13,70		1	
263003900	EU - USA	11,95		1	



No. 263003400



No. 263003900



No. 1500001065



No. 1500000587



No. SEH003800



No. SEH024600



No. SEH020300

Cartuchos desechables / Cartuchos descartáveis

1500001065	C200 PRO	5,30		36	
SEH003800	BTN 250	4,75		28	
SEH020300	BTP 300	8,50		24	
1500000587	C470	9,95		12	
SEH024600	ROMASSGAS	22,95		12	

No.	Descripción Descrição	P.V.P. unitario €		EAN 13
	Soplete Monoblock / Maçarico Monoblock 253000900 MONOBLOCK 22 mm	74,45	 1	
	Soplete ECO / Maçarico ECO 253000600 ECO Ø 22 mm	86,95	 1	
	Soplete AIRPROP / Maçarico AIRPROP P00408900 AIRPROP	109,45	 1	
	Soplete AIRPROP PLUS / Maçarico AIRPROP PLUS P00508900 AIRPROP PLUS	116,45	 1	
	Soplete TURBOPROP / Maçarico TURBOPROP P00109200 TURBOPROP	126,45	 1	
	Soplete de calentamiento ROMINI / Maçarico de aquecimento ROMINI 253500100 ROMINI Ø 45 mm	49,95	 1	
	Sopletes de calentamiento / Maçaricos de aquecimento 1000003558 Ø 63 mm	135,45	 1	
	Sopletes de calentamiento. Conexión espiga / Maçaricos de aquecimento. Conexão de pino 253031100 Ø 63 mm 253031200 Ø 57 mm	140,95 140,95	 1  1	 



No.	Descripción Descrição	P.V.P. unitario €		EAN 13
Queimadores estándar / Queimadores padrão				
223012200	Ø 22 mm	24,45		8 414162 102702
223012800	Ø 28 mm	24,45		8 414162 109836
223013200	Ø 32 mm	24,95		8 414162 101222
223013500	Ø 35 mm	26,95		8 414162 108819

Queimadores calentamiento / Queimadores aquecimento				
223014500	Ø 45 mm	30,95		8 414162 100826
223015100	Ø 51 mm	35,95		8 414162 100833
223015700	Ø 57 mm	40,95		8 414162 101222
223016300	Ø 63 mm	41,95		8 414162 101123

Queimadores calentamiento / antiviento Queimadores aquecimento / aanti-vento				
223213500	Ø 35 mm	29,95		8 414162 101126
223214500	Ø 45 mm	30,95		8 414162 101127
223215100	Ø 51 mm	36,95		8 414162 101129
223215700	Ø 57 mm	38,95		8 414162 101222
223216300	Ø 63 mm	40,95		4 1004625 139099

Lanzas / Lanças				
231010000	100 mm M14x1 - M20x1	22,95		8 414162 101318
232010000	200 mm M14x1 - M20x1	28,95		8 414162 100854
233510000	350 mm M14x1 - M20x1	35,95		8 414162 100807
236010000	600 mm M14x1 - M20x1	41,45		8 414162 100888

Boquillas AIRPROP / Bocal AIRPROP				
221111900	Ø 19 mm	47,95		8 414162 100785
221112200	Ø 22 mm	53,45		8 414162 100789

Boquillas TURBOPROP / Bocal TURBOPROP				
221011200	Ø 12 mm	59,95		8 414162 100768
221011500	Ø 15 mm	69,95		8 414162 100768
221011800	Ø 18 mm	67,95		8 414162 100768
221012400	Ø 24 mm	91,95		8 414162 107782

Soporte para soplete / Suporte para maçarico				
252010000	Para soplete / maçarico	6,15		8 414162 102034
252011100	Para brazo/ braço	15,75		8 414162 109834

Mangueras / Mangueiras				
1000000946	2 m W21,8I R3/8" I	40,95		4 1004625 138842
251266200	5 m W21,8I R3/8" I	55,95		8 414162 103862

Repuestos / Reposições				
210013000	Espiga	6,20		8 414162 109832
240140000	Tuerca hexagonal	5,80		8 414162 109836

Mangos / Punhos				
Mango con regulador gas / Punho con regulador de gás				
212111100	M14x1-3/8" I	52,95		8 414162 100764
212114100	M14x1 - espiga/pino 8 mm	23,40		8 414162 107240

Mango con regulador gas y llama / Punho con regulador de gás e chama				
211111100	M14x1-3/8" I	58,95		8 414162 100761
211114100	M14x1 - espiga/pino 8 mm	36,81		8 414162 107220
211115300	M14x1-3/8" I gatillo largo	61,45		8 414162 109833





No.	Descripción Descrição	P.V.P. unitario €		EAN 13
-----	--------------------------	----------------------	---	--------

Grifo de botella azul / Torneira para garrafa azul

254000200		14,95	1	
-----------	--	-------	---	---

Decapante universal soldadura blanda / Decapante universal soldadura leve

947005000	GEL 85 ml.	6,20	1	
947006000	Líquido 85 ml.	6,20	1	

Hilo soldadura blanda / Bobinas ssoldadura leve**Hilo estaño-cobre / Bobinas de estanho-cobre**

1500001179	Sn 97 Cu3 250g	27,45	1	
------------	----------------	-------	---	---

Hilo estaño-plata / Bobinas de estanho-plata

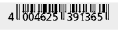
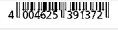
1500001180	3,5% (SnAg3,5) 250g	40,95	1	
1500001181	5% (SnAg5) 250g	46,45	1	
947003000*	6% (SnAg6) 250g	59,45	1	





*Venta a través de ROTHENBERGER

Decapante universal soldadura fuerte**Decapante universal soldadura forte**



940000300*	100 grs	10,95	1	
940000200*	250 grs	10,95	1	

*Venta a través de ROTHENBERGER



Varillas / Varetas**Varillas Cobre-Fósforo 8% / Varetas Cobre-Fósforo 8%**

1500001172*	500 mm Ø 2 mm 1Kg	44,45		1	
1500001173*	500 mm Ø 2 mm 250 grs.	10,95		1	



Varillas Cobre-Plata 2% / Varetas Cobre-Plata 2%

1500001174	500 mm Ø 2 mm 250 grs.	27,00		1	
------------	------------------------	-------	---	---	---



Varillas Cobre-Plata 5% / Varetas Cobre-Plata 5%

1500001175	500 mm Ø 2 mm 250 grs.	43,65		1	
------------	------------------------	-------	---	---	---



Varillas Cobre-Plata 15% / Varetas Cobre-Plata 15%

1500001176	500 mm Ø 2 mm 250 grs.	88,40		1	
------------	------------------------	-------	---	---	---



Cobre-Plata 20% / Cobre-Plata 20%

1500001177	500 mm Ø 2 mm 250 grs.	93,50		1	
------------	------------------------	-------	---	---	---



Para soldar aluminio / Para a brazagem de aluminio

SEH020100	500 mm Ø 2 mm / 5 uds.	16,95		1	
-----------	------------------------	-------	---	---	---



**Para tuberías de acero y acero galvanizado
Para a brazagem de tubulação de aços y aço galvanizado**

SEH020000	500 mm Ø 2 mm / 5 uds.	41,95		1	
-----------	------------------------	-------	---	---	---

**Para tubos y estructuras de acero
Para a brazagem de tubulação de aços y aço**



SEH019900	500 mm Ø 2 mm / 5 uds.	42,95		1	
-----------	------------------------	-------	---	---	---

**Con decapante para soldar latón, latón rojo y bronce
Com etchant de bronze de solda, latão vermelho e bronze**









SEH019800	500 mm Ø 2 mm / 5 uds.	16,95		1	
-----------	------------------------	-------	---	---	---

* Hasta agotar existencias

SOCKET WELDER

1500000447	20, 25 y 32 mm Ø	138,95	1	
1500000448	20, 25, 32, 40, 50 y 63 mm Ø	170,95	1	
1500000449	75, 90 y 110 mm Ø	234,95	1	

Matrices de calentamiento / Matrizes de aquecimento

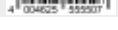
1500000687	20 mm	13,45	1	
1500000688	25 mm	13,95	1	
1500000689	32 mm	14,95	1	
1500000690	40 mm	15,95	1	
1500000713	50 mm	19,95	1	
1500000691	63 mm	24,95	1	
1500000692	75 mm	44,95	1	
1500000693*	90 mm	49,95	1	
1500000694*	110 mm	69,95	1	



No.	Descripción Descrição	P.V.P. unitario €		EAN 13
-----	--------------------------	----------------------	--	--------

TP25 Bomba de comprobación / Bomba de comprovaço

V15000000	0-25 bar manual	244,95	1	8 414162 072676
1000000590	Kit de mantenimiento	22,95		4 004625 381755

RP50-S Bomba de comprobación / Bomba de comprovaço

R6020000	0-60 bar manual	323,95	1	8 414162 072645
1000000591	Kit de mantenimiento	28,95		4 004625 381731

TP 120 Bomba de comprobación / Bomba de comprovaço

1000001903	0-120 bar manual	442,45	1	4 004625 473337
1000002163	Kit de mantenimiento	35,95		4 004625 466339

RP-PRO III Bomba de comprobación eléctrica / RP-PRO III Bomba de comprovaço eléctrica

V12100000		834,95	1	8 414162 108980
R6112500	Manguera L:1,2 m. R1/2"	31,45	1	8 414162 054092
1000001069	Kit mantenimiento	14,95		4 004625 391723

Bomba de desatascadora por agua / Bomba desentupidora por água

SEH0079		34,45	1	8 414162 109828
---------	--	-------	---	-----------------

Bomba de desatascadora por aire / Desentupidor doméstico por ar

SEH000200		80,95	6	8 414162 109373
-----------	--	-------	---	-----------------

Bomba desatascadora por golpe de aire / Bomba desentupidora por pressão de ar

1500000485		225,95	1	4 004625 380277
------------	--	--------	---	-----------------



No.	Descripción Descrição	P.V.P. unitario €		EAN 13
Desatascador de ventosa/ Desentupidor de ventosa				
SEH0224		4,75	11	



Muelle desatascador / Mola desentupidora				
67002000	2 m 7 mm Ø	18,95	10	
670050000	5 m 7 mm Ø	27,45	10	



Desatascadora manual de espiral / Desentupidora				
SEH004800		49,45	6	



Desatascadora de tambor manual/taladro Desentupidora de tambor manual/furadeira				
1500000484		128,95	6	



Varillas desatascadoras / Varetas desentupidoras				
SEH005000		44,95	1	



Desatascadores químicos / Desentupidores químicos				
SEH022700	DOMESTIC CLEANER	13,95	12	
SEH022600	PROFESSIONAL CLEANER	19,95	12	



Desatascadora por agua a presión / Desentupidora por água a pressão				
SEH019000	Desatascadora	1.525,00	1	
76089	Boquilla 4 orificios 25 x 22	137,45	1	
1500000678	Manguera alta presión 20 m.	143,45	1	







6



No.	Descripción Descrição	P.V.P. unitario €		EAN 13
-----	--------------------------	----------------------	---	--------

Obturdadores para tuberías domésticas Ø 50 - 200 mm
Obturdadores para tubagens domésticas Ø 50 - 200 mm

Presión de inflado 2,5 bar. Sólo para taponamiento
Pressão de enchimento 2,5 bar. Somente para tapamentos



Q86002200	Tipo Z1/Z2 para Ø 33-40 mm	76,95	1	
Q87858200	Tipo Z2 para Ø 50 mm	74,45	1	
Q87860300	Tipo Z2/3 para Ø 50-75 mm	106,45	1	
Q87860400	Tipo Z3/4 para Ø 75-100 mm	111,95	1	
Q87860500	Tipo Z4/6 para Ø 100-150 mm	262,45	1	
Q87860600	Tipo Z6/8 para Ø 150 - 200 mm	426,45	1	

Con by-pass. Presión de inflado 2,5 bar.
Añaden las aplicaciones de by-pass y comprobación de estanqueidad

Com by-pass. Pressão de 2,5 bar.
Incluem as aplicações de by-pass e comprovaçao de estanqueidade

Q87860700	Tipo S2 para Ø 50 mm	281,95	1	
Q87676800	Tipo S3 para Ø 75 mm	312,95	1	
Q87677000	Tipo S4 para Ø 100 mm	365,95	1	
Q87677200	Tipo S6 para Ø 150 mm	362,45	1	
Q87861400	Tipo S3/4 para Ø 75 -100 mm	388,45	1	
Q87860900	Tipo S4/6 para Ø 100 -150 mm	469,95	1	
Q87861000	Tipo S6/8 para Ø 150 -200 mm	532,45	1	

Accesorios / Acessórios

Q87890500	Manguera de inflado Mangueira de inflado 5 m	105,95	1	
Q86001000	Bomba manual de inflado Bomba manual de inflado	187,45	1	

Obturdadores para tuberías generales Ø 100 - 1500 mm
Obturdadores para tubagens gerais Ø 100 - 1500 mm

Obturdadores cilíndricos normales Sólo para taponamiento.
Obturdadores ovoides normais. Somente para tapamentos





Q86041700	Tipo N 100-200 para Ø 100-200 mm	413,45	1	
Q86041800	Tipo N 150-300 para Ø 150-300 mm	563,95	1	
Q86041900	Tipo N 200-400 para Ø 200-400 mm	627,45	1	
Q86042200	Tipo N 350-600 para Ø 350-600 mm	1.072,45	1	
Q86045300	Tipo N 500-800 para Ø 500-800 mm	2.318,95	1	
Q86042500	Tipo N 500-1000 para Ø 500-1000 mm	2.374,95	1	
Q87895700	Tipo N N 600-1200 para Ø 600-1200 mm	3.760,95	1	
Q87895900	Tipo N N 750-1500 para Ø 750-1500 mm	6.857,95	1	

Con by-pass. Presión de inflado 2,5 bar.
Añaden las aplicaciones de by-pass y comprobación de estanqueidad

Com by-pass. Pressão de 2,5 bar.
Incluem as aplicações de by-pass e comprovaçao de estanqueidade

Q86042900	Tipo BP 100-200 para Ø 100-200	1.021,95	1	
Q86043200	Tipo BP 150-300 para Ø 150-300	1.190,95	1	
Q86043400	Tipo BP 200-400 para Ø 200-400	1.379,45	1	
Q86044000	Tipo BP 350-600 para Ø 350-600	2.308,45	1	
Q86044200	Tipo BP 500-800 para Ø 500-800	4.011,95	1	
Q86045400	Tipo BP 500-1000 para Ø 500-1000	4.694,95	1	
Q87895800	Tipo BP 600-1200 para Ø 600-1200	5.265,45	1	
Q87896000	Tipo BP 750-1500 para Ø 750-1500	8.763,45	1	

Accesorios / Acessórios

Q87426800	Manguera de inflado. Long. 10 m.	145,95	1	
Q86031000	Controlador de inflado para 2,5 bar	368,95	1	
Q87460900	Controlador de inflado para 1,5 bar	325,45	1	
Q87465300	Controlador de inflado para 1 bar	308,95	1	



No.	Descripción Descrição	P.V.P. unitario €		EAN 13
-----	--------------------------	----------------------	--	--------

Bombas de vacío / Bombas de vácuo

1500002662	SEGO VAC 1.5 R32	218,95	1	4 004625 463802
1500002663	SEGO VAC 3.0 R32	248,95	1	4 004625 463819
1500001501	SEGO VAC 6.0	295,95	1	4 004625 397657

**Unidad de recuperación de refrigerante
Dispositivo de recuperação de refrigerante**

1500002664	SEGO REC V R32	876,45	1	4 004625 463826
------------	----------------	--------	---	-----------------

Manómetro SEGO MANFL / Manómetro SEGO MANFL

R410A

1500002233*	5/16"SAE - 2 vías	50,05		1	4 004625 407998
1500001402*	5/16"SAE - 4 vías	65,05		1	4 004625 396308

R22 R134A R407C R404A

1500002235	1/4" SAE - 2 vías	50,05		1	4 004625 408025
1500001403*	1/4" SAE - 4 vías	65,05		1	4 004625 396315

R32 R410A

1500002840	5/16"SAE - 2 vías	55,05		1	4 004625 467169
1500002665	5/16"SAE - 4 vías	65,05		1	4 004625 463833

* Hasta agotar existencias

Mangueras SEGO HS PRO / Mangueiras SEGO HS PRO

Juegos 3 mangueras / Conjuntos de 3 mangueiras

1500001406	5/16" SAE	45,05		1	4 004625 396346
1500001407	1/4" SAE	45,05		1	4 004625 396353
1500002841	5/16" - 1/4" SAE	45,05		1	4 004625 467176

Manguera / Mangueira

1500002842*	5/16" SAE	26,95		1	4 004625 467183
-------------	-----------	-------	--	---	-----------------

* Hasta agotar existencias

**Kit manómetro 4 vías + juego 3 mangueras
4 vías manómetro + Conjunto de 3 mangueiras**

R410A

1500001404*	5/16" SAE	101,65		1	4 004625 396322
-------------	-----------	--------	--	---	-----------------

R22 R134A R407C R404A

1500001405	1/4" SAE	101,65		1	4 004625 396339
------------	----------	--------	--	---	-----------------

R32 R410A

1500002666		101,65		1	4 004625 463840
------------	--	--------	--	---	-----------------

* Hasta agotar existencias

Báscula precisa SEGO SCL / Balança precisa SEGO SCL

1500001401		192,81	1	4 004625 396292
------------	--	--------	---	-----------------



No.	Descripción Descrição	P.V.P. unitario €		EAN 13
Termómetro digital SEGO TRM / Termómetro digital SEGO TRM				
1500001410		16,45	1	4 004625 396384



Detector SEGO DTCTR / Detector SEGO DTCTR				
1500001409		192,81	1	4 004625 396377



Abocinador universal / Abuzinador universal				
1500001408		60,45	1	4 004625 396360



R22 Abocinador / Abuzinador				
R22240200	1/8"-3/4"	162,97	1	8 414162 101798



491/492 Abocinadore / Abuzinadores				
491 Abocinador / Abuzinador				
491000000	3/16"-5/8"	40,95	1	8 414162 1002413
491030000	491 (doble abociador) + cortatubos 725	107,95	1	8 414162 1002437
491050000	491 + cortatubos 725	110,95	1	8 414162 1002440
492 Abocinador / Abuzinador				
492000000	4 - 14 mm	71,32	1	8 414162 1002536
492030000	492 (doble abociador) + cortatubos 725	99,95	1	8 414162 1002550
492050000	492 + cortatubos 725	107,95	1	8 414162 1002567

7



No.	Descripción Descrição	P.V.P. unitario €		EAN 13
Alicates / Alicates				
Alicate universal				
514010000	160 mm	6,20		6 8 414162 029731
514010100	180 mm	7,45		6 8 414162 029736
514010200	200 mm	8,30		6 8 414162 029755
Alicate corte lateral				
514011100	160 mm	6,20		6 8 414162 029781
514011200	180 mm	7,25		6 8 414162 029823
Alicate de teléfono boca redonda				
514010300	160 mm	6,20		6 8 414162 029762
Alicate de teléfono boca plana				
514010400	160 mm	6,20		6 8 414162 029779
Alicate corte frontal				
514011500	160 mm	7,25		6 8 414162 029809
Alicate para teléfono, boca rectas				
514010500	160 mm	6,20		6 8 414162 029786
514010700	200 mm	6,20		6 8 414162 029753
Alicate para teléfonos, boca curva				
514011000	160 mm	6,20		6 8 414162 029809
Pelacables / Descascador de fios				
514011400	160 mm	7,25		6 8 414162 029830
Juego de 4 alicates / Jogo de 4 alicates				
S51404000	160 mm	22,45		1 8 414162 093639

Juego de tenaza de canal + 2 alicates/ Jogo de tenaz de canal + 2 alicates

S00260000		35,45		1 8 414162 093877
-----------	--	-------	--	-------------------

Juego de 6 minialicates / Jogo de 6 mini-alicates

S51406000		21,95		1 8 414162 093646
-----------	--	-------	--	-------------------

Alicates de electricista / Alicates para electricista

Alicate universal				
SEH004200	160 mm	16,95		6 8 414162 092933
Alicate corte lateral				
SEH004300	160 mm	16,95		6 8 414162 092940
Pelacables / Descascador de fios				
SEH004400	160 mm	16,95		6 8 414162 092957
Alicate para teléfono, boca rectas				
SEH004500	160 mm	16,95		6 8 414162 092964
SEH009800	200 mm	16,95		6 8 414162 092955
Alicate para teléfonos, boca curva				
SEH009900	160 mm	16,95		6 8 414162 093008

**Set destornilladores electricista 1000 V. + Tester
Set de chave de fenda electricista 1000 V. + testador**

1500000629	2 destornilladores PH + ME	9,60		1 4 004625 388797
1500000671	4 destornilladores PH + ME	15,95		1 4 004625 388555



No.	Descripción Descrição	P.V.P. unitario €		EAN 13
-----	--------------------------	----------------------	--	--------

Destornilladores bi-material / Chaves de fendas bi-material

Presentación individual / apresentação individual

SEH010000	3 x 75 mm	3,00		1	
SEH010700	5 x 100 mm	3,60		1	
SEH010900	5 x 150 mm	4,45		1	
SEH011700	PH0 x 75 mm	3,00		1	
SEH011900	PH1 x 100 mm	3,60		1	
SEH012200	PH2 x 125 mm	4,45		1	

Set 2 destornilladores / Conjunto 2 chaves de fendas

1500000628	PH	7,25		1	
------------	----	------	--	---	--

Set 6 destornilladores / Conjunto 6 chaves de fendas

SEH009300	PH	14,45		1	
-----------	----	-------	--	---	--

Set 44 piezas / Set 44 peças

SEH003100		30,95		1	
-----------	--	-------	--	---	--

Set 6 destornilladores de precisión bi-material

Conjunto 6 chaves de fendas bi-material de precisión

SEH009400	PH	13,95		1	
-----------	----	-------	--	---	--

Set 6 destornilladores ERGO-MAX

Conjunto 6 chaves de fenda ERGO-MAX

F20235000	PH + ME + MF	33,95		1	
F20236000	PZ + ME + MF	43,45		1	

Set 6 destornilladores SUPER-EGO / Set 6 chaves de fenda SUPER-EGO

F09010600	PH + ME	22,45		6	
-----------	---------	-------	--	---	--

Set 8 destornilladores SUPER-EGO / Set 8 chaves de fenda SUPER-EGO

F09010800	PH + PZ + ME	23,45		1	
-----------	--------------	-------	--	---	--

Set destornillador 12 en 1 / Chave de fenda 12 em 1







F02023200		10,95		1	
F02023600		10,17		1	

Set de 29 puntas / Set de 29 pontas

SEH009600		6,40		12	
-----------	--	------	--	----	--

Set de 100 puntas / Set de 100 pontas

SEH001500		15,95		1	
-----------	--	-------	--	---	--

No.	Descripción Descrição	P.V.P. unitario €		EAN 13
Llave ajustable 135 / Llave ajustável 135				
135060000	6"	9,70		6 8 414 162 1 005955
135080000	8"	9,95		6 8 414 162 1 006308
135100000	10"	14,45		6 8 414 162 1 006133
135120000	12"	16,45		6 8 414 162 1 006022
135150000	15"	37,45		6 8 414 162 1 006039



Llave ajustable gran apertura / Llave ajustável gran apertura				
150000670	8"	25,45		6 4 004623 1 383735
SEH019200	10"	35,45		5 8 414 162 1 095354



Juego de 8 llaves fijas / Jogo de 8 chaves fixas				
SEH001000	8 llaves / 8 chaves	20,95		1 8 414 162 1 090564



Juego de 8 llaves estrella acotadas / Jogo de 8 chaves estrela acotoveladas				
SEH001100	8 llaves / 8 chaves	25,95		1 8 414 162 1 090571



Juego de 12 llaves combinadas / Jogo de 12 chaves combinadas				
SEH001200	12 llaves / 12 chaves	30,95		1 8 414 162 1 090588





Juego de 8 llaves combinadas con carraca / Jogo de 8 chaves combinadas com matraca				
SEH001300	8 llaves / 8 chaves	50,45		1 8 414 162 1 090793



Juego de 7 llaves combinadas con carraca articulada / Jogo de 7 chaves combinadas com matraca articulada				
SEH001400	7 llaves / 7 chaves	52,45		1 8 414 162 1 090809



Juegos de llaves de vaso / Jogos de chaves de vaso				
SEH000700	46 pcs. 1/4"	33,95		1 8 414 162 1 090353
SEH000800	58 pcs. 3/8"	88,95		1 8 414 162 1 090340
SEH000900	94 pcs. 1/4"-1/2"	113,45		1 8 414 162 1 090557



No.	Descripción Descrição	P.V.P. unitario €		EAN 13
Juego de 18 llaves, Allen + Torx inviolable Jogo de 18 chaves, Allen + Torx inviolável				
SEH003200		22,45		1 8 414162 1091392



Llaves Allen / Chaves Allen				
B40224300	1,5 - 10 mm Ø Cortas.	8,50		10 8 414162 102676
B40234300	1,5 - 10 mm Ø Largas.	10,95		10 8 414162 1000310



Llaves Allen / Chaves Allen				
B40121300	Ø 1,5 - 6 mm	8,30		10 8 414162 1000310
B40121500	Ø 2,5 - 10 mm	9,95		10 8 414162 1000310



Taladro percutor / Berbequim de percussão				
1500002650*		51,45		1 8 414162 1091337

* Hasta agotar existencias



Brocas escalonadas HSS / Brocas escalonadas HSS				
SEH005400	4-20 mm	42,45		1 8 414162 1093121
SEH005500	4-32 mm	76,45		1 8 414162 1093190



Coronas perforadoras bimetal / Coroa perfuradoras bimetal				
SEH006200*	HSS Ø 19 mm	11,95		1 8 414162 1093268
SEH006300*	HSS Ø 22 mm	11,95		1 8 414162 1093275
SEH006400	HSS Ø 29 mm	11,95		1 8 414162 1093282
SEH006500	HSS Ø 32 mm	11,95		1 8 414162 1093299
SEH006600	HSS Ø 40 mm	13,95		1 8 414162 1093305
SEH006700	HSS Ø 51 mm	13,95		1 8 414162 1093312
SEH006800*	HSS Ø 57 mm	15,95		1 8 414162 1093329



Juego				
SEH006900	19-22-29-38-44 y 57 mm Ø	81,66		1 8 414162 1093336





















Portasientos / Porta-assentos				
SEH007500	32-210 mm	19,45		1 8 414162 1093183

* Hasta agotar existencias

Tuercas perforadoras / Porcas perfuradoras				
SEH005600*	Ø 20,4 mm	21,95		1 8 414162 1093206
SEH005700	Ø 22,5 mm	23,45		1 8 414162 1093206
SEH005800	Ø 30,0 mm	27,95		1 8 414162 1093237
SEH005900	Ø 32,0 mm	29,45		1 8 414162 1093244
SEH006000	Ø 34,0 mm	28,95		1 8 414162 1093251
SEH006100	Ø 36,0 mm	31,45		1 8 414162 1093251

* Hasta agotar existencias

No.	Descripción Descrição	P.V.P. unitario €		EAN 13
	Cutter 1 + 2 cuchillas / Cutter 1 + 2 lâminas	2,95		12 8 414 162 1 097723
	Cutter AUTOMATIC 1 + 7 cuchillas / Cutter AUTOMATIC 1 + 7 lâminas	6,05		12 8 414 162 1 097730
	Cutter 1 + 5 cuchillas / Cutter 1 + 5 lâminas	5,70		12 8 414 162 1 097718
	Cutter 1 + 10 cuchillas / Cutter. 1 + 10 lâminas	6,85		12 8 414 162 1 097709
	Tijera electricista / Tesoura electricista 144 mm	9,35		1 8 414 162 1 063562
	Tijeras electricista bimaterial / Tesoura electricista bi-materiais 144 mm	25,95		1 8 414 162 1 063555
	Tijera multiusos / Tesoura multiusos 202 mm	25,95		1 8 414 162 1 007142
	Tijera multiusos bimaterial / Tesoura multiusos bi-material 202 mm	9,35		1 8 414 162 1 063566
	Tijera universal / Tesoura universal 195 mm	7,80		1 8 414 162 1 063579



No.	Descripción Descrição	P.V.P. unitario €		EAN 13
-----	--------------------------	----------------------	--	--------

Sierra mini / Serra mini

071203E		9,95		1	
---------	--	------	--	---	--

170 Arco de sierra / Arco de serra

17000000		11,45		10	
----------	--	-------	--	----	--

17010 Arco de sierra PRO / Arco de serra PRO

17010000		20,45		10	
----------	--	-------	--	----	--

Hojas de sierra BIMETAL / Lâminas de serra BIMETAL

SEH0240	L: 12" - 1/2" - 24 tpi	2,60		100	
SEH0230	L: 12" - 1/2" - 24 tpi / 2 uds.	5,15		1	

Hojas de sierra de acero al carbono / Lâminas de aço carbono

SEH0229	L: 12" - 1" - 24 tpi	1,15		50	
150000468	L: 12" - 1/2" - 24 tpi	2,20		100	

Discos de corte / Discos de corte

Metal					
855115100*	115 x 3 x 22,2 mm	2,20		1	
855230100*	230 x 3 x 22,2 mm	5,25		1	
Metal-Al.					
855115200	115 x 1,6 x 22,2 mm	3,65		1	
855125200	125 x 1,6 x 22,2 mm	3,65		1	
855115700	115 x 1 x 22,2 mm	3,65		1	
P85510500	115 x 1 x 22,2 mm (5 uds.)	9,15		1	
855125700	125 x 1 x 22,2 mm	5,25		1	

Flexómetro ERGOLOCK / Flexômetro ERGOLOCK

M31201400	3 m x 16 mm (verde)	2,69		6	
M31201900	5 m x 19 mm (naranja / laranja)	2,99		6	

Flexómetro ERGOCHROME / Flexômetro ERGOCHROME

M31201600	3 m x 16 mm	3,60		10	
M31201700	5 m x 19 mm	4,15		10	

Flexómetro ERGOPLUS / Flexômetro ERGOPLUS

M31200800	3 m x 16 mm	4,15		10	
M31200900	5 m x 19 mm	3,70		10	
M31201800	9 m x 25 mm	9,05		10	



No.	Descripción Descrição	P.V.P. unitario €		EAN 13
Maleta de cuero para fontanero / Mala de couro para canalizadores				
980020000*		112,27	1	8 414162 007319

* Hasta agotar existencias



Bolsa de herramientas + rodilleras / Bolsa de ferramentas + joelheiras				
1500000466*		62,95	1	4 004623 379456

* Hasta agotar existencias



Rodilleras / Joelheiras				
V39800000		5,05	2	8 414162 1006282



Carro de aluminio plegable / Carro de aluminio				
855092200		52,95	1	8 414162 1046224



Toallitas húmedas de limpieza ECO CLEANER Toalhinhas húmidas de limpeza ECO CLEANER				
1500000714	bote 90 uds.	40,95	1	4 004623 384354



Compresor de aire / Compressor de ar				
SEH004700		17,74	1	8 414162 1093554



No. 1500002288 No. 1500002289 No. 1500002290



No. 1500002291 No. RP1400000



No. 1500002292 No. 1500002293 No. 1500002294



No. 1500002295 No. 1500002296



No. 1500002297 No. 1500002298



No. 1500002301 No. 1500002302 No. 1500002303



No. 1500002305

No.	Descripción Descrição	P.V.P. unitario €		EAN 13
Bombas sumergibles aguas limpias / submersíveis água limpa				
1500002288	SEGO BLS-60. 6.000 L/H	60,45	1	4 004625 406510
1500002289	SEGO BLS-90. 9.000 L/H	67,45	1	4 004625 406527
1500002290	SEGO BLS-110i. 11.000 L/H	82,45	1	4 004625 406534
1500002291	SEGO BLS-55. 5.500 L/H	144,95	1	4 004625 406541
RP1400000	Trabajo continuo ULTRA 3000	108,95	1	8 1212162 1019008

Bombas sumergibles aguas sucias / submersíveis água suja				
1500002292	SEGO BTS-90 9.000 L/H	67,45	1	4 004625 406558
1500002293	SEGO BTS-135 13.500 L/H	78,95	1	4 004625 406565
1500002294	SEGO BTS-155 15.500 L/H	95,45	1	4 004625 406572
1500002295	SEGO BTS-155i 15.500 L/H	114,45	1	4 004625 406589
1500002296	SEGO BTS-250i 25.000 L/H	132,45	1	4 004625 406596

Bombas fuentes de jardín / Bombas fontes do jardim				
1500002301	SEGO BFS-14. 900 L/H	33,45	1	4 004625 411482
1500002302	SEGO BFS-26. 3.000 L/H	61,95	1	4 004625 411469
1500002303	SEGO BFS-36. 3.600 L/H	73,95	1	4 004625 411470

Bombas superficie / Bombas superfície				
1500002297	SEGO BJS-300. 3.000 L/H	105,95	1	4 004625 411380
1500002298	SEGO BFS-420. 4.200 L/H	125,95	1	4 004625 411377







Controlador de presión / Controlador de pressão				
1500002305	VCP-TRONIC	44,95	1	4 004625 411728

Grupos de presión / Grupos de pressão				
1500002299	TPS-360	193,95	1	4 004625 411384
1500002300	TPS-450	202,95	1	4 004625 411391

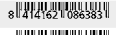
No.	Descripción Descrição	P.V.P. unitario €		EAN 13
-----	--------------------------	----------------------	---	--------





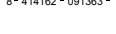







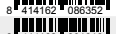



Conectores de grifo / Conectores de torneira

SD500800	1/2-3/4"	1,55		24	
SD500900	3/4-1"	1,95		24	
SD5002200	1/2-3/4" (granel)	1,35		120	
SD5002300	3/4-1" (granel)	1,90		80	

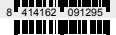

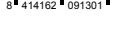
Conectores automáticos / Conectores automáticos

SD5000400	Aqua-Stop 1/2-5/8"	2,55		24	
SD5000500	Aqua-Stop 5/8 -3/4"	3,00		24	
SD5001800	Aqua-Stop 1/2-5/8" (granel)	2,35		60	
SD5001900	Aqua-Stop 5/8 -3/4" (granel)	2,80		30	
SD5000200	1/2-5/8"	2,40		24	
SD5000300	5/8 -3/4"	3,15		24	
SD5001600	1/2-5/8" (granel)	2,25		60	
SD5001700	5/8 -3/4" (granel)	2,70		30	



Reparador de manguera / Reparador de mangueira

SD5000600	1/2-5/8"	1,85		24	
SD5000700	3/4"	2,80		24	
SD5002000	1/2-5/8" (granel)	1,60		80	
SD5002100	3/4" (granel)	2,30		50	





Lanza rociadora / Lança pulverizadora

SD5001100	Lanza / Lança	2,80		24	
SD5001200	Lanza / Lança + set	9,70		12	

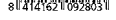

Pistola multifunción / Pistola multifunção

SD5001000	Pistola / Pistola	9,90		24	
SD5004700	Pistola / Pistola + set	12,45		12	

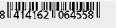

Programador de riego SEGO-TIMER / Programador de riego SEGO-TIMER

SD1000100	SEGO-TIMER	34,45		1	
-----------	------------	-------	---	---	---







No. SD3000100



No. SD3000300

Kit manguera espiral / Kit mangueira espiral

SD3000100	Espiral EVA	35,45		6	
SD3000300	Espiral PU	44,45		6	



No.	Descripción Descrição	P.V.P. unitario €		EAN 13
Ducha ajustable con trípode / Ducha ajustável com trip				
SD5000100		32,95		2



No. SD5004600

Tubo micro PE 1/4" / Tubo micro PE 1/4"				
SD5004600	20 m.	14,95	1	



No. SD5004400



No. SD5004100

Tubo principal PE 1/2" / Tubo principal PE 1/2"				
SD5004400	25 m	21,45	1	
SD5004500	50 m	36,45	1	
Tubo de riego con goteros / Tubo de rega com gotejos				
SD5004100	25 m	28,95	1	
SD5004200	50 m	53,95	1	



Recogedor automático / Recolhedor automático				
SD2000200	10 m.	119,45	1	
SD2000100	20 m.	140,95	1	



Carro portamangueras / Carrinho porta-mangueiras				
SD5001500		40,95	1	

Carro portamangueras equipado / Carrinho porta-mangueiras equipado				
SD5004800		71,54	1	



No.	Descripción Descrição	P.V.P. unitario €		EAN 13
Cocina portátil / Fogão portátil				
1500003888	Cocina	30,95	1	4 004625 544617
SEH003800	Cartuchos BTN 250	4,75	28	8 414162 109302



Cocina portátil 2 fuegos / Fogão portátil 2 fogos				
SEH024800	Cocina / Fogão	51,45	1	8 414162 109302



Hornillo de camping / Fogão de campismo					
SEH025300	Hornillo / Fogão	30,45		1	8 414162 1099789
1500001065	BTP C200 PRO	5,30		36	4 004625 390821



Hornillo de camping / Fogão de campismo					
1500000590	Hornillo / Fogão	30,45		1	4 004625 382882



Lámpara de camping / Lâmpada de campismo					
1500004425	Lampara / Lâmpada	31,45		1	8 414162 1099772
1500001065	BTP C200 PRO	5,30		36	4 004625 390821



Expositor negro SUPER-EGO

Dimensiones montado: 1.000 x 2.200 x 600 mm.

Los expositores incluyen:

- Panel trasero y 2 postes
- Cabecero con 3 focos (No. 1500003591)
- 1 balda 570 mm (No. 1500003586)
- 1 base
- 2 brazos para balda 570 mm (No. 1500003587)
- 20 ganchos sencillos (No. 1500000611)
- 20 ganchos dobles (No. 1500000625)

Display preto SUPER-EGO

Dimensões montadas: 1.000 x 2.200 x 600 mm.

Expositores incluem:

- Painel traseiro e 2 postes
- Cabeceira com 3 focos (No. 1500003591)
- 1 prateleira 570 mm (No. 1500003586)
- 1 base
- 2 braços para prateleira de 570 mm (No. 1500003587)
- 20 ganchos simples (No. 1500000611)
- 20 ganchos duplos (No. 1500000625)

No.		
1500004109	Expositor negro SUPER-EGO desmontado	1

Accesorios para expositor negro Acessórios para display preto



No. 1500003586

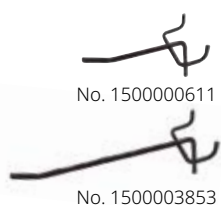

No. 1500000611

No. 1500003853

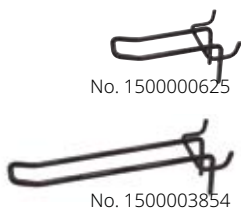

No. 1500000625

No. 1500003854



No. 1500003587



No. 995914700



No. 1500003591

No.		
1500003586	1 bandeja 1.000 x 570 mm	1
1500003587	1 brazo para bandeja de 570 mm	1
1500000611	20 ganchos - 100 mm	1
1500003853	20 ganchos - 200 mm	1
1500000625	20 ganchos dobles - 100 mm	1
1500003854	20 ganchos dobles - 200 mm	1
1500003591	Cabecero con 3 LEDs	1
995914700	Cartón fin de gancho	1



No. 4100000272



No. 4100000274

Expositor blanco SUPER-EGO

Dimensiones montado: 1.000 x 2.280 x 450 cm.

Los expositores incluyen:

- Panel trasero y 2 postes
- 1 balda 400 cm y 2 dos brazos (No. 4100000276)
- 1 base
- 15 ganchos cortos

Display branco SUPER-EGO

Dimensões montadas: 1.000 x 2.280 x 450 cm.

Expositores incluem:

- Painel traseiro e 2 postes
- 1 prateleira de 400 cm e 2 dois braços (nº 4100000276)
- 1 base
- 15 ganchos curtos

No.		
4100000270	Expositor desmontado sin cabecero	1
4100000272	Cabecero sin luz 1.000 x 200 mm	1
4100000274	Cabecero con luz 1.000 x 200 mm	1



Presentación orientativa

Vitrina SUPER-EGO

Dimensiones montada: 1.000 x 2.280 x 450 mm.

Los expositores incluyen:

- Panel trasero y laterales, puertas correderas y base con pies graduables.
- Cabecero 2 focos
- 1 balda (1.000 x 300 mm) y dos brazos.
- 15 ganchos cortos

Vitrine SUPER-EGO

Dimensões montadas: 1000 x 2280 x 450 mm.

Expositores incluem:

- Painel traseiro e laterais, portas de correr e base com pés reguláveis.
- Cabeceira com 2 focos
- 1 prateleira (1.000 x 300 mm) e dois braços.
- 15 ganchos curtos

No.		
4100000573	Vitrina SUPER-EGO (sin producto)	1



No. 4100000276



No. 4100000793



No. 4100000277



No. 4100000657



No. 995914700

Accesorios para expositor y vitrina (blanco) Acessórios para display e vitrine (branco)

No.		
4100000276	Balda + 2 brazos (1.000 x 300 mm)	1
4100000793	Balda + 2 brazos (1.000 x 400 mm)	1
4100000277	10 ganchos cortos	1
4100000657	10 ganchos largos	1
995914700	Cartón fin de gancho	1

Condiciones generales de venta para España

PRECIOS:

Los precios incluidos en esta tarifa son **P.V.P., impuestos no incluidos**. Los precios de venta al profesional son a título indicativo y no constituyen una oferta en firme por parte de **SUPER-EGO TOOLS, S.L.U.**. Serán precios válidos para la factura aquellos que estén en vigor en la fecha de entrega.

Debido a cambios en las especificaciones, cantidades, materias primas, costo de producción u otros términos y condiciones, **SUPER-EGO TOOLS, S.L.U.** se reserva el derecho de modificar los precios en cualquier momento sin previo aviso.

CONDICIONES DE VENTA:

1. Estas condiciones corresponden a la tarifa válida desde el **1 de enero de 2026** que sustituye y anula todas las anteriores.
2. Los precios de esta tarifa se entienden para mercancía puesta en fábrica.
3. Estas condiciones de venta de **SUPER-EGO TOOLS, S.L.U.** son las únicas válidas, incluso en caso de que las de compra de nuestros clientes fueran distintas. El mero hecho de cursar un pedido a nuestra empresa significa la aceptación de las mismas.
4. **SUPER-EGO TOOLS, S.L.U.** se reserva el derecho de modificar las especificaciones técnicas y dimensionales de sus artículos sin previo aviso.

PEDIDO MÍNIMO:

No se aceptan pedidos por importe neto **inferior a 100 €**.

No se aceptan pedidos de Ceuta y Melilla por un importe neto **inferior a 350 €**

No se aceptan pedidos de Canarias por un importe neto **inferior a 750 €**

PORTES Y MANIPULACIÓN:

1. **Se suministran con recargo de 10 €** (en concepto de portes y manipulación):
Los pedidos de la Península y Baleares de importe neto comprendido **entre 100 € y 250 €**
2. **Se suministran sin recargos:** Todos los envíos de importe neto superior a **250 €**

NOTAS:

1. Los pedidos para Canarias, Ceuta y Melilla, superiores a **750 €** netos incluyen el seguro hasta el puerto de destino.
2. Se recomienda a todos los Clientes comprobar el perfecto estado de precintos y embalajes al retirar el pedido del transportista y proceder en caso de su anomalía, a la inmediata reclamación, en un plazo máximo de **cuatro días**, al medio de transporte empleado comunicándolo por escrito a **SUPER-EGO TOOLS, S.L.U.**
3. Se entiende la aceptación por el Cliente de los artículos, cantidades, calidades y en su caso los precios, si transcurridos 15 días naturales desde la entrega física de los mismos, no nos manifiesta expresamente su disconformidad por escrito.

FORMA DE PAGO:

Pago a 60 días fecha factura Neto.

A los clientes que tengan día de vencimiento fijo, se les emitirá factura a 45 días, respetando ese día fijo de vencimiento.

Toda mercancía es propiedad de **SUPER-EGO TOOLS, S.L.U.** hasta que no haya sido hecho efectivo su total cobro, conforme a factura.

DEVOLUCIÓN DE MERCANCÍA

En ningún caso se aceptarán devoluciones de género sin la previa autorización de SUPER-EGO TOOLS, S.L.U. y deberán acompañarse del "PARTE DE DEVOLUCIÓN" de nuestro Delegado o Representante previamente autorizados por la Administración o Dirección de ventas.

1. **SUPER-EGO TOOLS, S.L.U.** sólo aceptará las devoluciones por defecto de fabricación o error en el envío atribuible a **SUPER-EGO TOOLS, S.L.U.** que sean devueltas a fábrica dentro de los 15 días desde su expedición.
2. En ningún caso se admitirán devoluciones de artículos no incluidos en esta tarifa, ni provenientes de promociones o saldos. No se aceptarán devoluciones de herramientas en cardings o displays defectuosos.
3. Sólo se admitirán aquellas devoluciones que vengan a **portes pagados**.
4. Para aceptar una devolución deberá venir documentada con una **fotocopia de la/s factura/s original/es**.
5. **A todas las devoluciones (salvo las correspondientes al apartado 1) se les deducirá un 50% (consecuencia de su manipulación, recuento, inspección del control de calidad y recuperación), si fuese necesaria.**

REPARACIONES:

1. Los artículos a reparar, deberán enviarse con la **Solicitud de reparación** debidamente rellenada, la cual puede descargarse de nuestra página web: **www.super-ego.com**.
2. Los artículos a reparar en garantía deberán venir acompañados de la **fotocopia de la factura de compra**.

GARANTÍA:

Los productos que aparecen en la tarifa **SUPER-EGO** tienen una **garantía de 1 año a partir de la fecha de compra, salvo casos excepcionales que se disponga una garantía superior.**

La **garantía cubre el cambio o reparación de las piezas defectuosas, siempre y cuando los defectos no sean causados por un uso anormal.** Toda herramienta, máquina o equipo, para su cambio o reparación, antes deberá ser sometida a control en nuestro Departamento Técnico.

AVISO LEGAL:

SUPER-EGO TOOLS, S.L.U. excluye toda responsabilidad, que se le pudiera exigir derivada de posibles errores de impresión (precios, fotografías, información técnica, descripciones ...).

SUPER-EGO TOOLS, S.L.U.

PREÇOS:

Os preços incluídos nesta tarifa são **P.V.P., não incluem impostos**. Os preços de venda ao profissional são indicativos e não constituem uma oferta vinculativa da **SUPER-EGO TOOLS, S.L.U.**. Os preços válidos para a fatura serão os que estiverem em vigor na data de entrega. Devido a alterações nas especificações, quantidades, matérias-primas, custos de produção ou outros termos e condições, a **SUPER-EGO TOOLS, S.L.U.** reserva-se o direito de alterar os preços a qualquer momento sem aviso prévio.

CONDIÇÕES DE VENDA:

1. Estas condições correspondem à tarifa válida a partir de **1 de janeiro de 2026** que substitui e anula todas as anteriores.
2. Os preços desta tarifa serão para mercadorias colocadas em fábrica.
3. Estas condições de venda de **SUPER-EGO TOOLS, S.L.U.** são as únicas válidas, inclusive em caso de que as de compra de nossos clientes fossem distintas. O simples facto de fazer um pedido à nossa empresa significa a aceitação das mesmas.
4. **SUPER-EGO TOOLS, S.L.U.** reserva-se o direito de modificar as especificações técnicas e dimensionais de seus artigos sem aviso prévio.

ENCOMENDA MÍNIMA:

Não se aceitam encomendas por importe líquido inferior a **100 €**.

Não se aceitam encomendas por importe líquido inferior a **350 € dos arquipélagos dos Açores e da Madeira**.

PORTES E MANIPULAÇÃO:

Os valores das encomendas das nossas 2 marcas ROTHENBERGER e SUPER-EGO, registadas no mesmo dia serão sumadas a efeitos de portes e manipulação.

1. **São fornecidos com agravação de 10 €** (em razão de portes e manipulação):
As encomendas de importe líquido compreendido **entre 100 € e 350 €**
As encomendas de Açores e Madeira de importe líquido compreendido **entre 350 € e 750 €**
2. **São fornecidos sem agravação:** Todos os envios de importe líquido superior a **250 €**.

NOTAS:

1. As encomendas para Açores e Madeira, superiores a **750 €** líquido incluem o seguro até o porto de destino.
2. Recomenda-se a todos os Clientes que comprovem o perfeito estado de precintos e embalagens ao retirar a encomenda da transportadora e proceder em caso de anormalia, à imediata reclamação, num prazo máximo de **quatro dias**, ao meio de transporte utilizado comunicando-o por escrito a **SUPER-EGO TOOLS, S.L.U.**
3. Entende-se a aceitação pelo Cliente dos artigos, quantidades, qualidades e no caso os preços, se passados 15 dias naturais desde a entrega física dos mesmos, não nos manifeste expressamente a sua reclamação por escrito.

PAGAMENTO:

Pagamento a 60 dias: mediante domiciliação bancária Líquido

Aos clientes que tenham dia de vencimento fixo, a factura será emitida a 45 dias, respeitando o dia fixo de vencimento.

Toda a mercadoria é propriedade de **SUPER-EGO TOOLS, S.L.U.** até que não tenha sido efectuada a cobrança total, conforme a factura.

DEVOLUÇÃO DA MERCADORIA:

Em nenhum caso serão aceites devoluções de mercadorias sem a prévia autorização de SUPER-EGO TOOLS, S.L.U. e deverão ser acompanhadas pelo "AVISO DE DEVOLUÇÃO" do nosso Delegado ou Representante previamente autorizados pela Administração ou Direcção de Vendas.

1. **SUPER-EGO TOOLS, S.L.U.** somente aceitará as devoluções por defeito de fabricação ou erro no envio atribuível a SUPER-EGO TOOLS, S.L.U. que sejam devolvidas à fábrica dentro dos 15 dias de sua expedição.
2. Em nenhum caso serão admitidas devoluções de artigos não incluídos nesta tarifa, nem provenientes de promoções ou liquidação. Não serão aceites devoluções de ferramentas em cardings ou displays defeituosos.
3. Somente serão admitidas àquelas devoluções que venham a **portes pagos**.
4. Para que uma devolução seja aceite deverá vir certificada com uma **cópia das facturas originais**.
5. **A todas as devoluções (excepto as correspondentes no ponto 1) serão deduzidas um 50% (consequência de sua manipulação, recontagem, inspeção do controlo de qualidade e recuperação), se fosse necessária.**

CONSERTOS

1. Para os artigos a reparar, deve realizar-se uma **Solicitude de reparação**, a qual pode ser realizada através do site: **www.super-ego.com**.
2. Os produtos enviados para reparação durante o período de garantia, deverão vir acompanhados de uma **cópia da factura de compra**.

GARANTIA:

Os produtos que aparecem na Tabela Geral de Preços SUPER-EGO têm uma garantia de 1 ano desde a data da compra, excepto casos excepcionais que se aplique uma garantia superior.

A garantia cobre a troca ou conserto das peças defeituosas, sempre e quando os defeitos não sejam causados por um uso anormal.

Toda a ferramenta, máquina ou equipamento, para sua troca ou conserto, deverá ser submetida, antes, a um controlo em nosso Departamento Técnico.

AVISO LEGAL:

SUPER-EGO TOOLS, S.L.U. exclui toda a responsabilidade que se lhe pudesse exigir derivada de possíveis erros de impressão (preços, fotografias, informação técnica, descrições ...).

SUPER-EGO TOOLS, S.L.U.

SUPER•EGO

HEAVY DUTY TOOLS

Servicio Atención al Cliente

Ctra. Durango - Elorrio km. 2
48220 Abadiño (Bizkaia)
Apartado 117 • 48200 Durango (España)
Tel.: 94 621 01 01
ventas@super-ego.com

Servicio de Asistencia Técnica

Tel. 94 621 01 06
sat@super-ego.com

Delegación Norte

Ctra. Durango-Elorrio km. 2
48220 Abadiño (Bizkaia)
Tel.: 607 371 672
norte@super-ego.com

Delegación Noroeste

Avda. de los Cubos, 52 1-B
24007 León
Tel.: 609 419 478
noroeste@super-ego.com

Delegación Noreste

Benjamin Franklin, 34. Pol. Ind. Cogullada
Guardatodo - BOX 101
50014 Zaragoza
Tel.: 696 623 223
noreste@super-ego.com

Delegación Centro

San Máximo, 31 Planta 2 - Nave 1
28041 Madrid
Tel.: 91 500 19 01
centro@super-ego.com

Delegación Cataluña

C/ Zamora, 46 Bajo
08191 RUBI (Barcelona)
Tel.: 93 207 69 75 / 660 400 650
catalunya@super-ego.com

Delegación Baleares

Tel.: 607 274 944
baleares@super-ego.com

Delegación Levante

C/ Ricardo Llopis, 4 - Bajo
46183 - La Eliana (Valencia)
Tel.: 648 035 488
levante@super-ego.com

Delegación Sur

C/ Cazalleja de Almanzor, 24 - A
41960 - Gines (Sevilla)
Tel.: 660 390 729
sur@super-ego.com

Delegación Sureste

Pol. Ind. SAN LUIS
C/ Bahía Blanca, 13- BOX 975
29006 - Málaga
Tel.: 670 365 026
sureste@super-ego.com

Delegación Canarias

Tel.: 662 952 311
canarias@super-ego.com

Delegación Portugal

Tel.: +351 91 868 38 94
portugal@super-ego.com



www.super-ego.com

Tarifa válida desde el 1 de enero hasta el 31 de diciembre de 2026 y/o publicación de nueva tarifa. Tarifa de precios recomendados P.V.P., impuestos no incluidos. Debido a cambios en las especificaciones, cantidades, materias primas, costo de producción u otros términos y condiciones todos los precios están sujetos a cambios en cualquier momento sin previo aviso. Sujeto a errores tipográficos o de impresión.

Tabela de preços, válida de 1 de janeiro a 31 de dezembro de 2026 ou até acabar as existências. Preços de venda ao público (PVP) recomendados, impostos não incluídos. Devido às alterações nas especificações, quantidades, matérias-primas, custos de produção ou outros termos e condições, os preços estão todos sujeitos a alterações em qualquer momento sem aviso prévio. Sujeito a erros tipográficos ou de imagem.